

E – Series Brazen Plate Heat Exchangers



Construction

The Plate Heat Exchangers ASA-PL is designed for hydraulic fluid and lubricating. The benefits of plate heat exchangers are:

- strength
- installation dimension
- efficiency
- low maintenance

Design

The structure of the ASA-PL cooling surfaces, i. thin, profiled plates made of acid-proof stainless steel (1.4306) is compact and powerful. The plates are profiled on the one hand to achieve optimum heat transfer and on the other hand to form channels in which oil or water is guided. The plate pack has a cover plate on each side. The entire heat exchanger is soldered together at the outer edges and at the inner points of contact. The cooler can be installed in a feed pump circuit and in return lines with large pressure variations. This product is also suitable for water, air and gas.

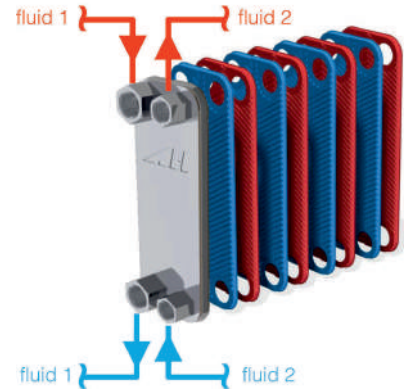

Standard Range

Our standard range of plate heat exchanger covers a large field of applications to ensure you competitive pricing, high quality and short delivery times. Contact us for more information and non standard coolers to work out the optimal solution for you.

Technical Data

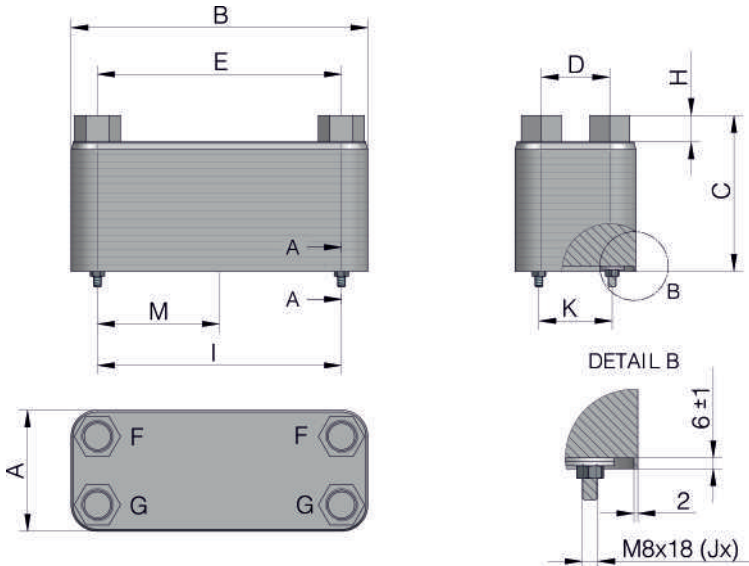

material

plates	steel 1.4306
upper plate	steel 1.4306
connectors	steel 1.4306
solder	copper

temperature

max.working temperature	-160°C to +200 °C
-------------------------	-------------------

pressure

test pressure	43 bar
max. pressure	30 bar

order number	description	A	B	C	D	E	F	G	H	I	J	K	M	weight
		[mm]	[mm]	[mm]	[mm]	[mm]			[mm]	[mm]	#bolt	[mm]	[mm]	[kg]
ILWPL10014EKI00	ASA – PL 10-14 E	73	205	65,5	42	172	G ½"	G ½"	27	120	2	-	-	1,8
ILWPL20020EKI00	ASA – PL 20-20 E	80	194	85	40	154	G ¾"	G ¾"	27	150	2	-	-	1,6
ILWPL22030EKI00	ASA – PL 22-30 E	106	306	111,5	50	250	G 1"	G ¾"	27	250	4	40	-	5,2
ILWPL22060EKI00	ASA – PL 22-60 E	106	306	183,5	50	250	G 1"	G ¾"	27	250	4	40	-	8,8
ILWPL40050EKI00	ASA – PL 40-50 E	124	304	159,5	70	250	G 1"	G 1"	27	250	4	75	-	8,5
ILWPL53020EKI00	ASA – PL 53-20 E	124	504	87,5	64	444	G 1"	G 1"	27	450	4	75	-	8,3
ILWPL53040EKI00	ASA – PL 53-40 E	124	504	135,5	64	444	G 1"	G 1"	27	450	4	75	-	13,1
ILWPL53060EKI00	ASA – PL 53-60 E	124	504	183,5	64	444	G 1"	G 1"	27	450	4	75	-	17,9
ILWPL70020EKI00	ASA – PL 70-20 E	246	528	86,5	174	456	G 1½"	G 1½"	27	420	6	150	210	17,6
ILWPL70060EKI00	ASA – PL 70-60 E	246	528	182,5	174	456	G 1½"	G 1½"	27	420	6	150	210	39,9
ILWPL70120EKI00	ASA – PL 70-120 E	246	528	326,5	174	456	G 1½"	G 1½"	27	420	6	150	210	69,6
ILWPL70160EKI00	ASA – PL 70-160 E	246	528	422,5	174	456	G 1½"	G 1½"	27	420	6	150	210	90,4

This data sheet and the corresponding scale drawings are to be used as a general guideline and technical overview of our products. Please contact us if more exact information is needed. As we are constantly improving our products, their characteristics, dimensions and weights may also change, although we do our best to incorporate these changes continually. asa assumes no liability for any information therein, any errors, omissions, misprints, nor any direct or indirect damages, losses or costs resulting therefrom. Any cooling performances and general technical values indicated in this catalogue are measured at a test bench according to asa testing procedures or calculated, based on such tests. Because there is no standardized testing procedure, tests used by other manufacturers could have different results. Due to different conditions in testing and application environments the cooling performance may also vary by +/- 15%. Therefore we recommend all products to be checked under the system operating conditions. This is also true of vibrations and mechanical stress as well as for pressure peaks and thermal stress and any other relevant factors. General tolerances according to DIN ISO 2768-v, General tolerances for casted parts according EN ISO 8062-3 (DCTG 10). Tolerances for rubber parts are according to ISO 3302-1 (class M4-F+C). The tolerances of welding seams are defined by quality group D according to EN ISO 10042, if it is not specified on the actual scale drawing or data sheet. In addition to that we point out that any data sheet and corresponding scale drawing is no substitution for the manual.
DK-TS-special-ranges-ind-rev0

E – Series Brazen Plate Heat Exchangers



The shown performance curves created at an oil / water ratio of 2:1 with hydraulic oil ISO VG 32 at an oil inlet temperature of 60°C and a water entrance of 20°C. Please contact us for other technical parameters to select the optimal cooler for you.

colling performance

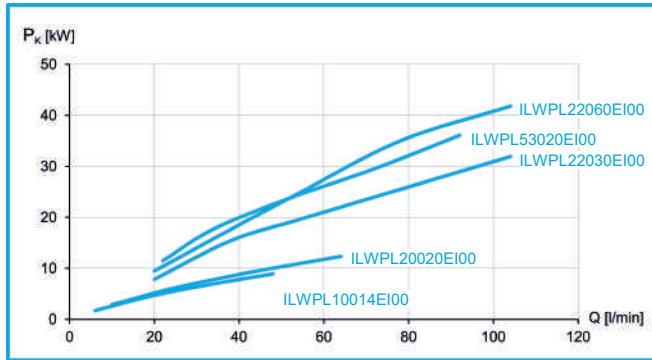

pressure drops (oil side)

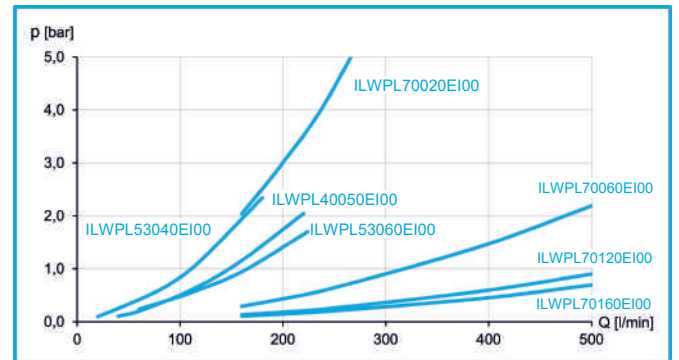
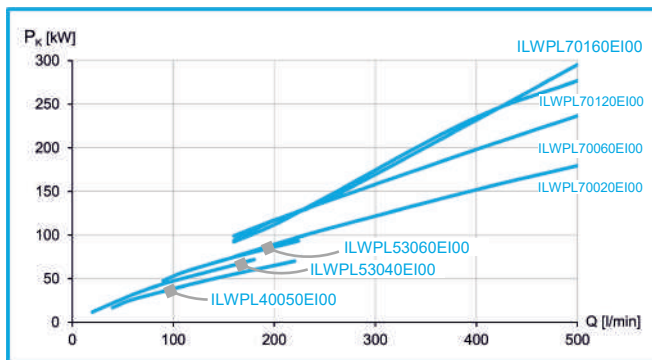
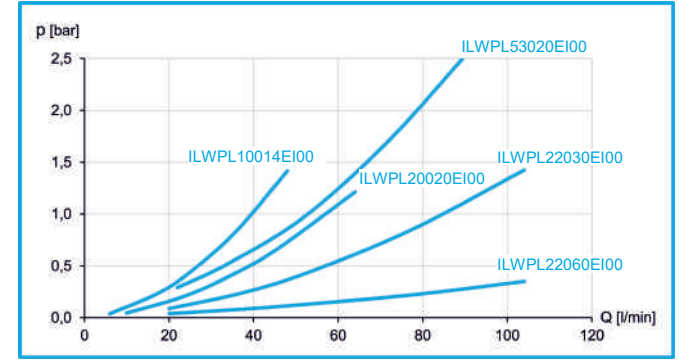

Mounting brackets

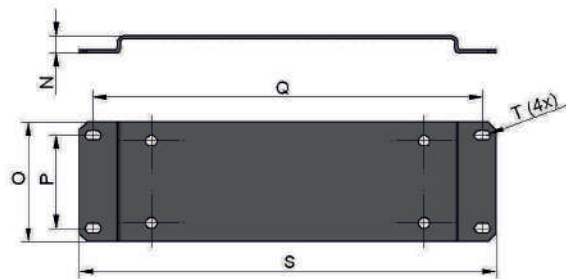

cooler number with mounting brackets
ILWPL10014EPI00
ILWPL20020EPI00
ILWPL22030EPI00
ILWPL22060EPI00
ILWPL40050EPI00
ILWPL53020EPI00
ILWPL53040EPI00
ILWPL53060EPI00
ILWPL70020EPI00
ILWPL70060EPI00
ILWPL70120EPI00
ILWPL70160EPI00

order number	description	N	O	P	Q	S	T slot hole	weight
		[mm]	[mm]	[mm]	[mm]	[mm]		[kg]
ILWPZMON10I00	ASA – PL 10-14E	16	58	33	228	253	9 x 15	0,3
ILWPZMON20I00	ASA – PL 20-20E	16	70	50	255	280	9 x 15	0,5
ILWPZMON22I00	ASA – PL 22-__E	16	74	50	350	375	9 x 15	0,7
ILWPZMON40I00	ASA – PL 40-50E	16	109	85	357	382	9 x 15	1,0
ILWPZMON53I00	ASA – PL 53-__E	16	107	85	555	580	9 x 15	1,5
ILWPZMON70I00	ASA – PL 70-__E	16	254	230	552	580	11 x 20	3,5

Please contact us for details or get further information at www.asahydraulik.com or support@asahydraulik.com
Please read the manual before operating

This data sheet and the corresponding scale drawings are to be used as a general guideline and technical overview of our products. Please contact us if more exact information is needed. As we are constantly improving our products, their characteristics, dimensions and weights may also change, although we do our best to incorporate these changes continually. asa assumes no liability for any information therein, any errors, omissions, misprints, nor any direct or indirect damages, losses or costs resulting therefrom. Any cooling performances and general technical values indicated in this catalogue are measured at a test bench according to asa testing procedures or calculated, based on such tests. Because there is no standardized testing procedure, tests used by other manufacturers could have different results. Due to different conditions in testing and application environments the cooling performance may also vary by +/- 15%. Therefore we recommend all products to be checked under the system operating conditions. This is also true of vibrations and mechanical stress as well as for pressure peaks and thermal stress and any other relevant factors. General tolerances according to DIN ISO 2768-v, General tolerances for casted parts according EN ISO 8062-3 (DCTG 10). Tolerances for rubber parts are according to ISO 3302-1 (class M4-F+C). The tolerances of welding seams are defined by quality group D according to EN ISO 10042, if it is not specified on the actual scale drawing or data sheet. In addition to that we point out that any data sheet and corresponding scale drawing is no substitution for the manual.
DK-TS-special-ranges-ind-rev0
© asa hydraulic October 2019